

Détails caisse Pz II Ausf A (1) :

Nota :

Les protections blindées de la tourelle et des trappes latérales ne sont pas présentes sur les pz Ausf A. Elles seront introduites sur les derniers engins de cette série. Rétroactivement, elles seront installées sur l'ensemble de cette production.

Armoured protection of the turret and hatches are not present on the pz Ausf A. They will be introduced on the last machines of this series. Retroactively, they will be installed on all of this production.

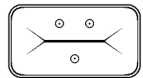

(1 - Coté gauche.)
 - Left side. -

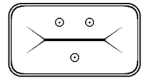

(2 - Arrière.)
 - Front left. -

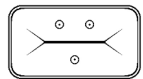

(3 - Coté droit.)
 - Right side. -

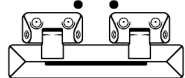

(4 - Avant.)
 - Front. -

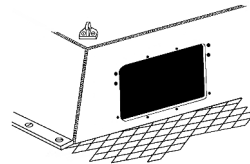
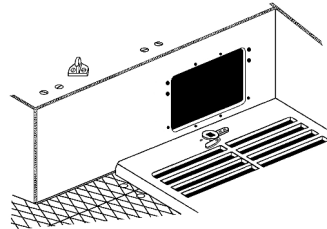

(Arrière & côtés droit.)
 - Rear & right sides. -

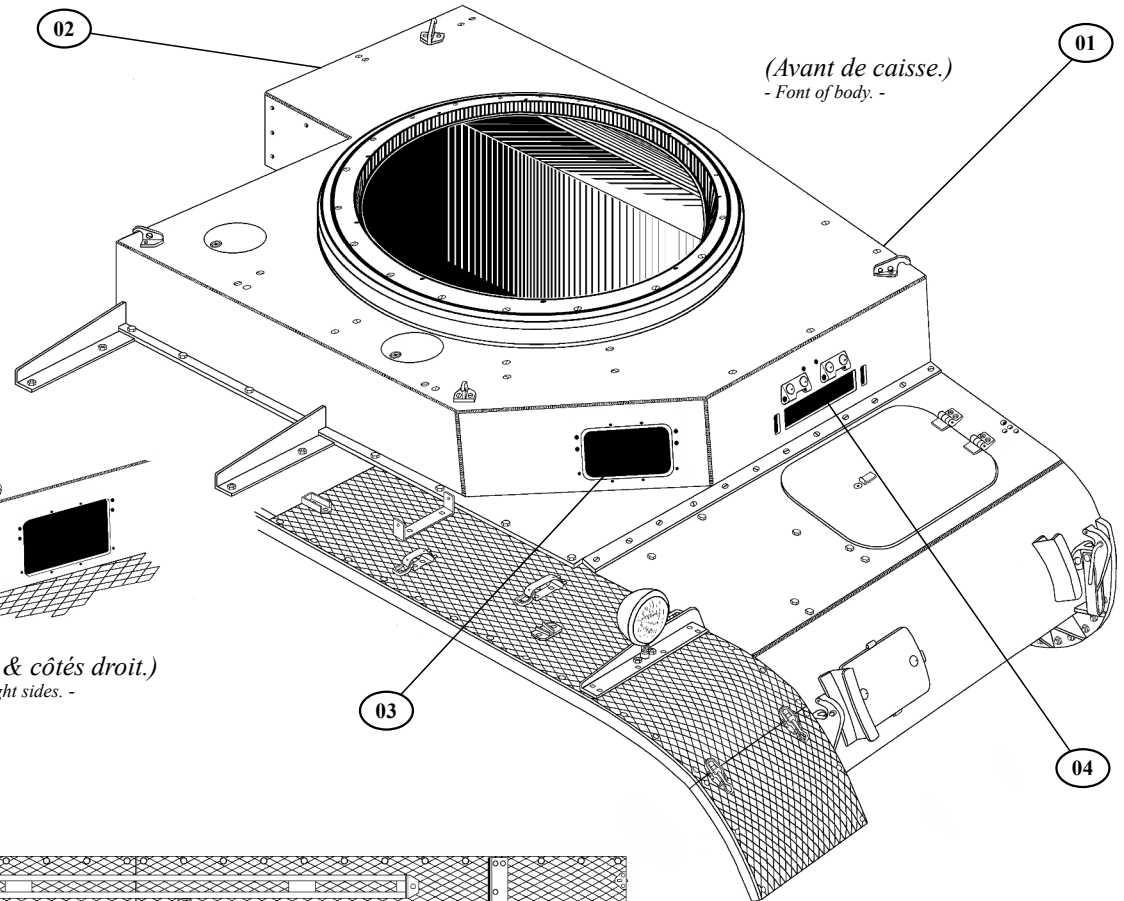

(Avant de caisse.)
 - Font of body. -

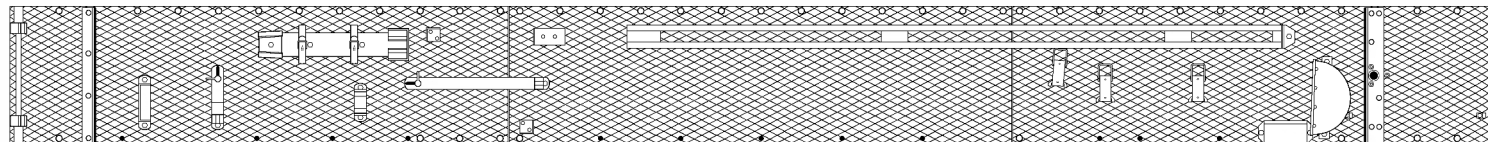

(Garde boue gauche.) - Left fender. -

PAQUIS Jacky